

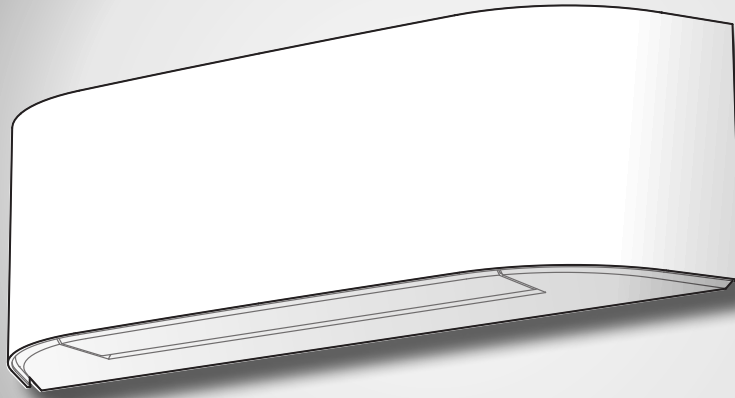

R32

INSTALLATION MANUAL
AIR CONDITIONER (SPLIT TYPE)



Indoor unit

- 42GCVPH010-303P**
- 42GCVPH013-303P**
- 42GCVPH018-303P**

Outdoor unit



- 38GCVPH010-303P**
- 38GCVPH013-303P**
- 38GCVPH018-303P**



1129850113

PRECAUTIONS FOR SAFETY	1
ACCESSORY AND INSTALLATION PARTS	5
INSTALLATION DIAGRAM OF INDOOR AND OUTDOOR UNITS	6
■ Optional Installation Parts.....	6
INDOOR UNIT	7
■ Installation Place.....	7
■ Cutting a Hole and Mounting Installation Plate.....	7
■ Piping and Drain Hose Installation	8
■ Indoor Unit Fixing.....	9
■ Drainage	10
OUTDOOR UNIT	11
■ Installation Place.....	11
■ Refrigerant Piping Connection.....	11
■ Evacuating	12
ELECTRICAL WORKS	13
■ Power Supply and Connecting Cable Connection.....	14
■ Power Supply Input Wiring Diagram.....	14
OTHERS	15
■ Gas Leak Test.....	15
■ Remote Control A-B Selection	15
■ Test Operation	15
■ Auto Restart Function Setting	15
■ Decorative Fabric Installation	16
APPENDIX	17

PRECAUTIONS FOR SAFETY

	<p>Read the precautions in this manual carefully before operating the unit.</p>		<p>This appliance is filled with R32.</p>
---	---	---	---

■ Warning indications on the air conditioner unit

Warning indication	Description
<div style="border: 1px solid black; padding: 5px;"> <div style="display: flex; align-items: center;">  <div style="margin-left: 5px;"> <p>CAUTION</p> </div> </div> <hr style="border: 0.5px solid black; margin: 5px 0;"/> <p>BURST HAZARD Open the service valves before the operation, otherwise there might be the burst.</p> </div>	<p>CAUTION</p> <p>BURST HAZARD Open the service valves before the operation, otherwise there might be the burst.</p>

- Before installation, please read these precautions for safety carefully.
 - Be sure to follow the precautions provided here to avoid safety risks. The symbols and their meanings are shown below.
- WARNING** : It indicates that incorrect use of this unit may cause severe injury or death.
- CAUTION** : It indicates that incorrect use of this unit may cause personal injury (*1), or property damage (*2).
- *1: Personal injury means a slight accident, burn, or electrical shock which does not require admission or repeated hospital treatment.
 - *2: Property damage means greater damage which affects assets or resources.

For general public use

Power supply cord and connecting cable of appliance use shall be at least polychloroprene sheathed flexible cord (design H07RN-F) or cord designation 60245 IEC66. (Shall be installed in accordance with national wiring regulations.)

CAUTION To disconnect the appliance from the main power supply

This appliance must be connected to the main power supply by means of a circuit breaker or a switch with a contact separation of at least 3 mm in all poles.

DANGER

- FOR USE BY QUALIFIED PERSONS ONLY.
- TURN OFF MAIN POWER SUPPLY BEFORE ATTEMPTING ANY ELECTRICAL WORK. MAKE SURE ALL POWER SWITCHES ARE OFF.
FAILURE TO DO SO MAY CAUSE ELECTRIC SHOCK.
- CONNECT THE CONNECTING CABLE CORRECTLY. IF THE CONNECTING CABLE IS CONNECTED WRONGLY, ELECTRICAL PARTS MAY BE DAMAGED.
- CHECK THE EARTH WIRE THAT IT IS NOT BROKEN OR DISCONNECTED BEFORE INSTALLATION.
- DO NOT INSTALL NEAR CONCENTRATIONS OF COMBUSTIBLE GAS OR GAS VAPORS.
FAILURE TO FOLLOW THIS INSTRUCTION CAN RESULT IN FIRE OR EXPLOSION.
- TO PREVENT OVERHEATING THE INDOOR UNIT AND CAUSING A FIRE HAZARD, PLACE THE UNIT WELL AWAY (MORE THAN 2 M) FROM HEAT SOURCES SUCH AS RADIATORS, HEATERS, FURNACE, STOVES, ETC.
- WHEN MOVING THE AIR CONDITIONER FOR INSTALLING IT IN ANOTHER PLACE AGAIN, BE VERY CAREFUL NOT TO GET THE SPECIFIED REFRIGERANT (R32) WITH ANY OTHER GASEOUS BODY INTO THE REFRIGERATION CYCLE. IF AIR OR ANY OTHER GAS IS MIXED IN THE REFRIGERANT, THE GAS PRESSURE IN THE REFRIGERATION CYCLE BECOMES ABNORMALLY HIGH AND IT RESULTINGLY CAUSES BURST OF THE PIPE AND INJURIES ON PERSONS.
- IN THE EVENT THAT THE REFRIGERANT GAS LEAKS OUT OF THE PIPE DURING THE INSTALLATION WORK, IMMEDIATELY LET FRESH AIR INTO THE ROOM. IF THE REFRIGERANT GAS IS HEATED BY FIRE OR SOMETHING ELSE, IT CAUSES GENERATION OF POISONOUS GAS.

WARNING

- Never modify this unit by removing any of the safety guards or bypassing any of the safety interlock switches.
- Do not install in a place which cannot bear the weight of the unit.
Personal injury and property damage can result if the unit falls.
- Before doing the electrical work, attach an approved plug to the power supply cord.
Also, make sure the equipment is properly earthed.
- Appliance shall be installed in accordance with national wiring regulations.
If you detect any damage, do not install the unit. Contact your dealer immediately.
- Do not use any refrigerant different from the one specified for complement or replacement.
Otherwise, abnormally high pressure may be generated in the refrigeration cycle, which may result in a failure or explosion of the product or an injury to your body.
- Do not use means to accelerate the defrosting process or to clean, other than those recommended by the manufacturer.

- The appliance shall be stored in a room without continuously operating ignition sources (for example: open flames, an operating gas appliance or an operating electric heater).
- Be aware that refrigerants may not contain an odour.
- Do not pierce or burn as the appliance is pressurized. Do not expose the appliance to heat, flame, sparks, or other sources or ignition. Else, it may explode and cause injury or death.
- For R32 model, use pipes, flare nut and tools which is specified for R32 refrigerant. Using of existing (R22) piping, flare nut and tools may cause abnormally high pressure in the refrigerant cycle (piping), and possibly result in explosion and injury.
- Thickness of copper pipes used R32 must be more than 0.8 mm. Never use copper pipes thinner than 0.8 mm.
- Do not perform flare connection inside a building or dwelling or room, when joining the heat exchanger of indoor unit with interconnection piping. Refrigerant connection inside a building or dwelling or room must be made by brazing or welding. Joint connection of indoor unit by flaring method can only be made at outdoor or at outside of building or dwelling or room. Flare connection may cause gas leak and flammable atmosphere.
- After completion of installation or service, confirm there is no leakage of refrigerant gas. It may generate toxic gas when the refrigerant contacts with fire.
- Appliance and pipe-work shall be installed, operated and stored in a room with a floor area larger than A_{\min} m².
How to get A_{\min} m²: $A_{\min} = (M / (2.5 \times 0.22759 \times h_0))^2$
M is the refrigerant charge amount in appliance in kg, h_0 is the installation height of the appliance in m: 0.6 m for floor standing/1.8 m for wall mounted/1.0 m for window mounted/2.2 m for ceiling mounted. (For these units recommend installation height 2.5 m)
- Comply with national gas regulations.
- Do not add any other devices without factory advice.

WARNING

- **After installation work, make sure below before operation.**
 - **Connection pipes are connected properly and no leakage.**
 - **Packed valves are fully open.**

Running compressor without open packed valves may cause abnormal high pressure and parts failure.
Leakage at connection piping may suck air and make further high pressure cause burst and injure.
- **During pump down work make sure below process.**
 - **Don't mix air into the refrigerant cycle.**
 - **Stop the compressor before removing piping after packed valves are fully closed.**

Removing piping under the compressor running and packed valves open, air might be sucked and refrigeration cycle pressure becomes abnormally high, and it causes burst or injury on persons.

CAUTION

- Exposure of unit to water or other moisture before installation could result in electric shock.
Do not store it in a wet basement or expose to rain or water.
- After unpacking the unit, examine it carefully for possible damage.
- Do not install the unit at place where leakage of flammable gas may occur. In case gas leaks and accumulates at surrounding of the unit, it may cause of fire.
- Do not install in a place that can increase the vibration of the unit. Do not install in a place that can amplify the noise level of the unit or where noise and discharged air might disturb neighbors.
- To avoid personal injury, be careful when handling parts with sharp edges.
- Please read this installation manual carefully before installing the unit. It contains further important instructions for proper installation.
- The manufacturer shall not assume any liability for the damage caused by not observing the description of this manual.

REQUIREMENT OF REPORT TO THE LOCAL POWER SUPPLIER

Please make absolutely sure that the installation of this appliance is reported to the local power supplier before installation. If you experience any problems or if the installation is not accepted by the supplier, the service agency will take adequate countermeasures.

■ Important information regarding the refrigerant used

This product contains fluorinated greenhouse gases.

Do not vent gases into the atmosphere.

Refrigerant type: **R32**













GWP⁽¹⁾ value: **675** * (ex. R32 ref. AR4)

⁽¹⁾GWP = global warming potential

The refrigerant quantity is indicated on the unit name plate.

* This value is based on F gas regulation 517/2014

ACCESSORY AND INSTALLATION PARTS

Indoor Unit			
No.	Part name	No.	Part name
①	 Installation plate × 1	②	 Wireless remote control × 1
③	 Battery × 2	④	 Remote control holder × 1
⑤	 Ultra pure filter × 2	⑥	 Mounting screw × 10
⑦	 Flat head wood screw × 2	⑧	 Screw × 2
⑨	 Owner's Manual × 1	⑩	 Installation Manual × 1
⑪	 Decorative fabric (dark gray) × 1	⑫	 Decorative fabric (light gray) × 1

Air filter

Clean every 2 weeks.

1. Open the air inlet grille.
2. Remove the air filters.
3. Vacuum or wash and then dry them.
4. Reinstall the air filters and close the air inlet grille.

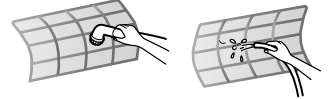
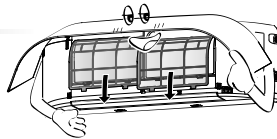

Filter

Maintenance & Shelf-life

Clean every 3-6 months when dust stuck or covers the filter.

1. Recommend to use vacuum to clean by sucking the dusts which stick or dip inside the filter or use the blower to blow the dust out through the filter.
2. If necessary to use water to clean, simply use the plain water to wash the filter, dry with the sunlight for 3-4 hours or until it completely dry. Nevertheless, use hair drier to dry it. However, washing with water, it may reduce the performance of the filter.
3. Replace every 2 years or sooner. (contact your dealer to purchase new filter) (P/N : RB-A622DA)

Note: Filter life depends on the level of impurities in your operating environment. Higher levels of impurities may require more frequent cleaning and replacement. In all cases, we recommend an additional set of filters to improve the purifying and deodorizing performance of your air conditioner.

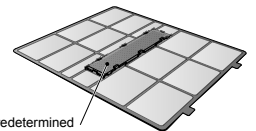
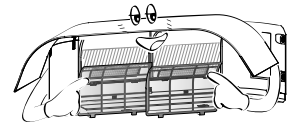

Attach filter to predetermined position of air filter

Decorative fabric

Maintenance & Shelf-life

- Clean when dust stuck or covers the decorative fabric.
- Take extra care when cleaning the decorative fabric.
- Vacuum the decorative fabric with soft brush nozzle that use for cleaning on furniture or curtain.
- In case of getting heavy dirty on decorative fabric, please use dry cleaning service or wash by hand with warm water separated from other clothes (to avoid color staining), then line dry in the shade.

Note:

- Switch 'OFF' and unplug the air conditioner before removing the grille and decorative fabric.
- Ensure decorative fabric are completely dry before refitting to the grille.
- Do not put the decorative fabric in a dishwasher, washing machine, tumble dryer, oven, microwave or near an open flame.

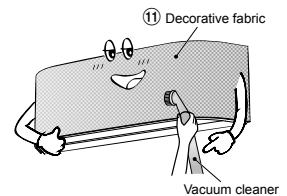

Vacuum cleaner

INSTALLATION DIAGRAM OF INDOOR AND OUTDOOR UNITS

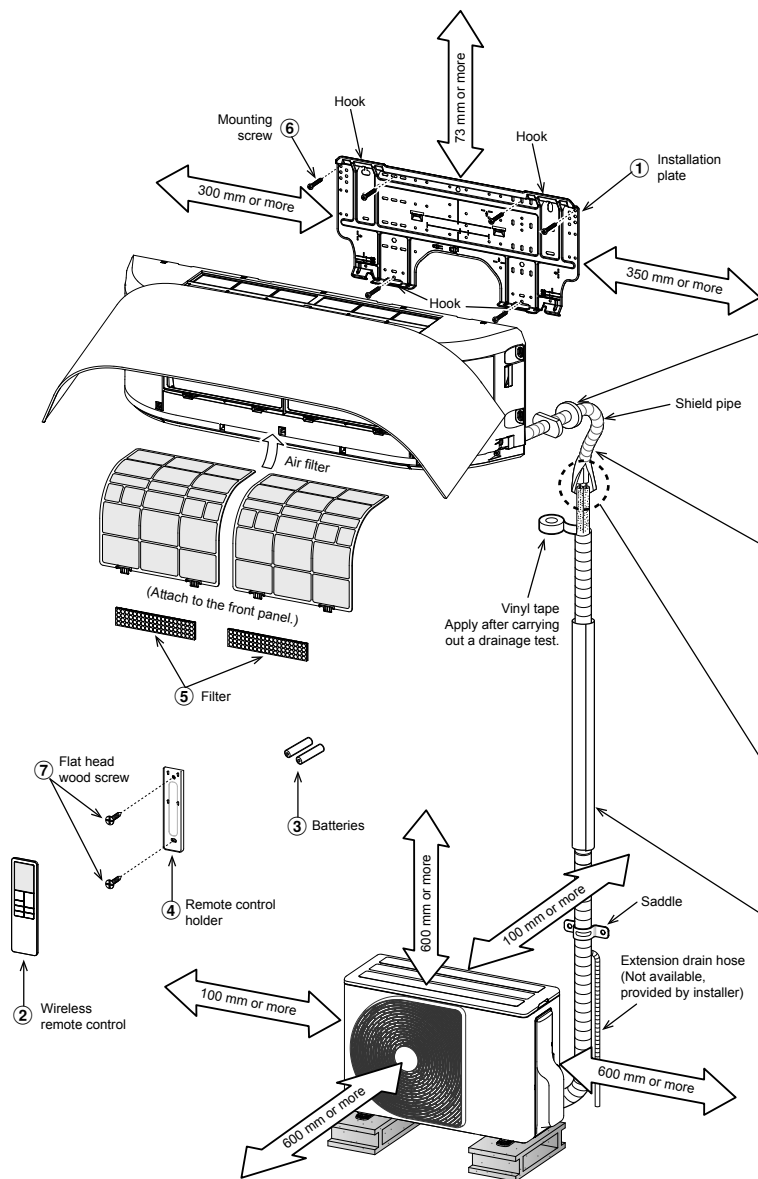

For the rear left and bottom left piping

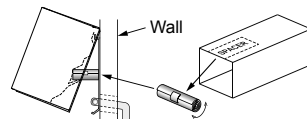

Cut out a piece of SPACER from indoor unit packaging box, roll it and insert between the indoor unit and wall to tilt the indoor unit for better operation.

The auxiliary piping can be connected to rear left, rear right, bottom right or bottom left.

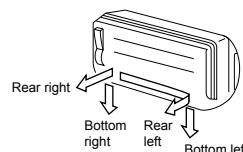

Do not allow the drain hose to get slack.

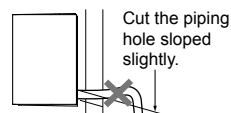

Make sure to run the drain hose sloped downward.

The flare connection should be installed outdoors.

Refrigerant piping must be protected from physical damage. Install a plastic cover or equivalent.

Insulate the refrigerant pipes separately with insulation, not together.

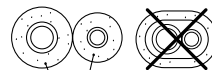

6 mm or 8 mm thick heat resisting polyethylene foam

Optional Installation Parts

Part code	Parts name	Q'ty
Ⓐ	Refrigerant piping Liquid side : $\varnothing 6.35$ mm Gas side : $\varnothing 9.52$ mm (42GCVP010, 013-303P) : $\varnothing 12.70$ mm (42GCVP018-303P)	One each
Ⓑ	Pipe insulating material (polyethylene foam, 6 mm thick) For 42GCVP010, 013-303P (polyethylene foam, 8 mm thick) For 42GCVP018-303P	1
Ⓒ	Putty, PVC tapes	One each

Fixing bolt arrangement of outdoor unit

- Secure the outdoor unit with fixing bolts and nuts if the unit is likely to be exposed to a strong wind.
- Use $\varnothing 8$ mm or $\varnothing 10$ mm anchor bolts and nuts.

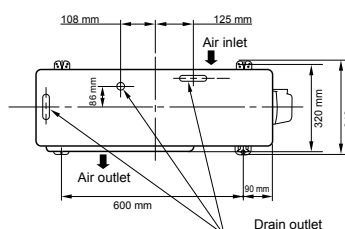

INDOOR UNIT

Installation Place

- A place which provides the spaces around the indoor unit as shown in the diagram
- A place where there are no obstacles near the air inlet and outlet
- A place which allows easy installation of the piping to the outdoor unit
- A place which allows the front panel to be opened
- The indoor unit shall be installed at least 2.5 m height. Also, it must be avoided to put anything on the top of the indoor unit.

CAUTION

- Direct sunlight to the indoor unit's wireless receiver should be avoided.
- The microprocessor in the indoor unit should not be too close to RF noise sources.
(For details, see the owner's manual.)

Remote control

- A place where there are no obstacles such as a curtain that may block the signal from the indoor unit.
- Do not install the remote control in a place exposed to direct sunlight or close to a heating source such as a stove.
- Keep the remote control at least 1 m apart from the nearest TV set or stereo equipment. (This is necessary to prevent image disturbances or noise interference.)
- The location of the remote control should be determined as shown below.

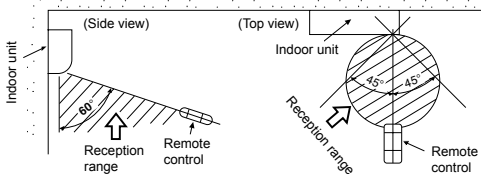

Cutting a Hole and Mounting Installation Plate

Cutting a hole

When installing the refrigerant pipes from the rear

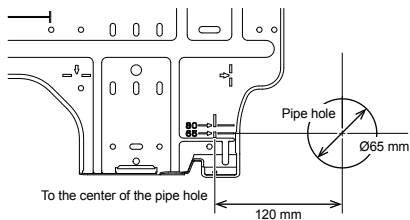

1. After determining the pipe hole position on the mounting plate (➔), drill the pipe hole (Ø65 mm) at a slight downward slant to the outdoor side.

NOTE

- When drilling a wall that contains a metal lath, wire lath or metal plate, be sure to use a pipe hole brim ring sold separately.

Mounting the installation plate

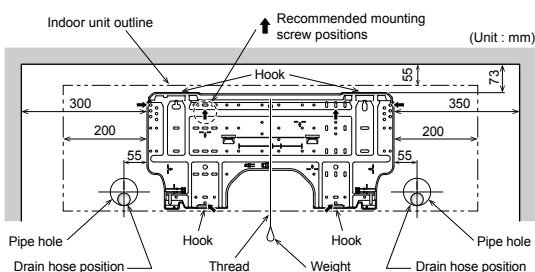

- Space allows for moving range of the air inlet grille and horizontal louver in operation above curtain rails, window cornice or other objects.

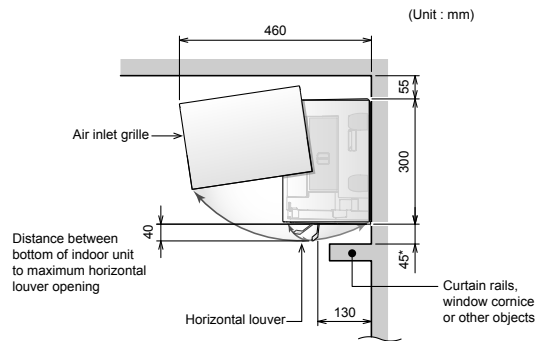

CAUTION

- If have curtain rails, window cornice or other objects, allow space from the indoor unit should be 45 mm or more.
- If allow space is less than 45 mm, this can affect the opening and closing of the air inlet grille and the horizontal louver.
- However, there should be no objects in the air outlet position. It will block the air flow direction and drop performance.

When the installation plate is directly mounted on the wall

1. Securely fit the installation plate onto the wall by screwing it in the upper and lower parts to hook up the indoor unit.
2. To mount the installation plate on a concrete wall with anchor bolts, use the anchor bolt holes as illustrated in the below figure.
3. Install the installation plate horizontally in the wall.

CAUTION

When installing the installation plate with a mounting screw, do not use the anchor bolt holes. Otherwise, the unit may fall down and result in personal injury and property damage.

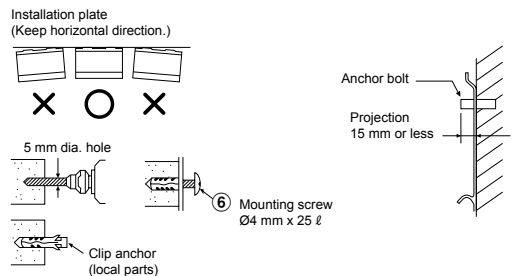

CAUTION

Failure to firmly install the unit may result in personal injury and property damage if the unit falls.

- In case of block, brick, concrete or similar type walls, make 5 mm dia. holes in the wall.
- Insert clip anchors for appropriate mounting screws ⑥.

NOTE

- Secure four corners and lower parts of the installation plate with 4 to 6 mounting screws to install it.

Piping and Drain Hose Installation

Piping and drain hose forming

- Since dewing results in a machine trouble, make sure to insulate both connecting pipes. (Use polyethylene foam as insulating material.)
- The connection of pipes can be installed in the following directions.

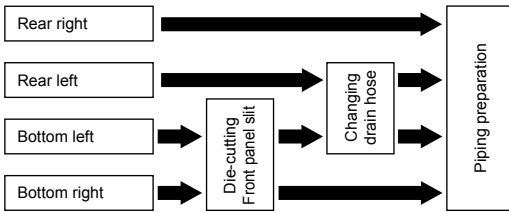

• Rear right

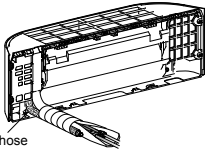

Drain hose

• Rear left

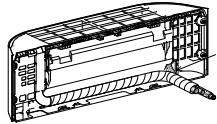

Drain hose

• Bottom right

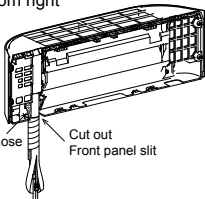

Drain hose

• Bottom left

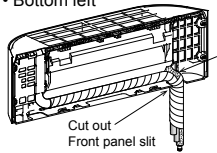

Drain hose

1. Die-cutting Front panel slit

- Cut out the slit on the bottom left or bottom right side of the Front panel for the bottom left or bottom right connection with a coping saw or an equivalent tool.

2. Changing drain hose

- The factory default of the drain hose is installed on the right side.
- For bottom-leftward connection and rear leftward connection's piping, it is necessary to change the drain hose and drain cap.

How to cutting the Front panel

- To connect piping to the bottom side, the Front panel must be cut off.
- The front panel can be removed by removing 2 screws securing then secure remove the front panel from the main body.
- ※ Be careful of air inlet grill fall down that may cause of injury or part damage.

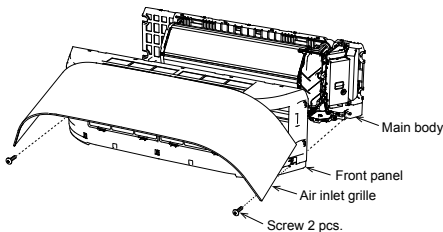

- The marking for cutting are indicated on the inside of the Front panel in the following positions.

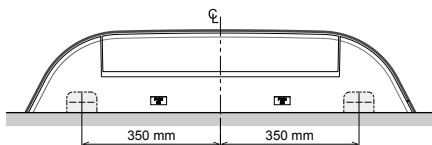

- Cut off the pipe exist from inside of Front panel using a coping saw or an equivalent tool.
- The plastic burrs from the cutting process should be removed with a half round file or an equivalent tool.

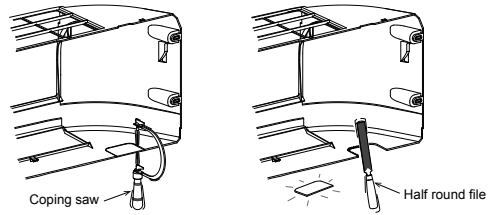

CAUTION

When cutting the Front panel, be careful of cutting tools and any sharp edges of plastic. It can cause injuries.

How to remove the drain hose

- Removed fixing screw of LED set then pull out it from the main body.
- Removed 2 screws to fix drain pan then secure remove the drain pan from the main body.

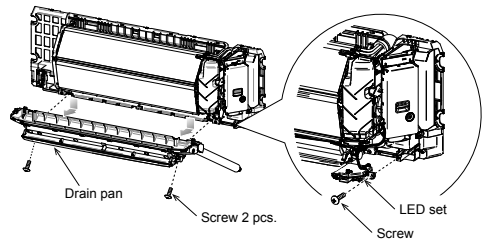

- The drain hose can be removed by removing the screw securing the drain hose then secure rotate steel plate of drain hose to out of the Drain pan and pulling out the drain hose.

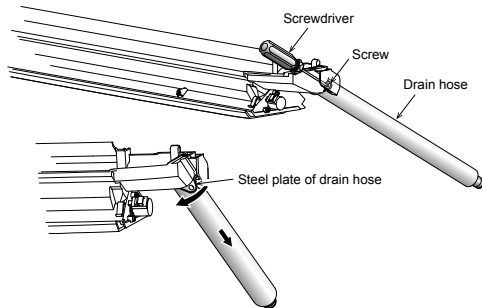

How to fix the drain hose

- To install the drain hose, insert the drain hose firmly until the connection part contacts with heat insulator (foam), secure push steel plate of drain hose to predetermined position of Drain pan then fix it by original screw.

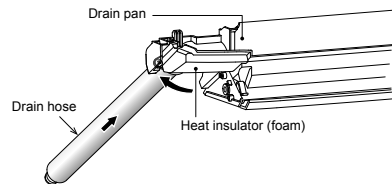

CAUTION

When removing or install the drain hose, be careful of any sharp edges of steel plate. The edges can cause injuries.

How to remove the drain cap

- Clip the drain cap by needle-nose pliers and pull out.

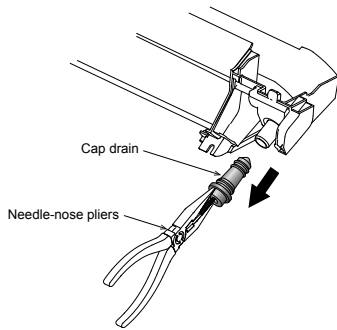

How to fix the drain cap

- Insert hexagonal wrench (dia. 4 mm) in a center head.

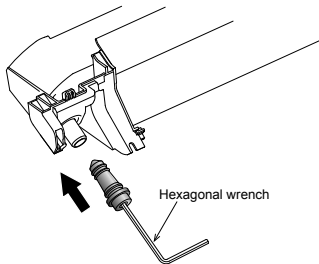

- Firmly insert the drain cap.

Do not apply lubricating oil (refrigerant machine oil) when inserting the drain cap. Application causes deterioration and drain leakage from the plug.

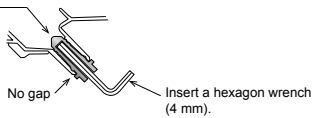

CAUTION

Firmly insert the drain hose and drain cap; otherwise, water may leak.

Left-hand connection with piping

- Bend the connecting pipe so that it is laid within 43 mm above the wall surface. If the connecting pipe is laid exceeding 43 mm above the wall surface, the indoor unit may unstably be set on the wall. When bending the connecting pipe, make sure to use a spring bender so as not to crush the pipe.

Bend the connecting pipe within a radius of 30 mm.

To connect the pipe after installation of the unit (figure)

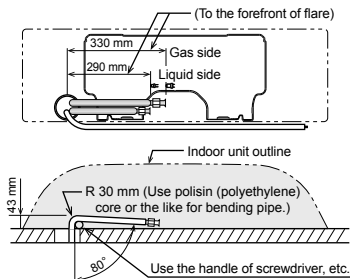

NOTE

If the pipe is bent incorrectly, the indoor unit may unstably be set on the wall. After passing the connecting pipe through the pipe hole, connect the connecting pipes to the auxiliary pipes and wrap the facing tape around them.

CAUTION

- Bind the auxiliary pipes (two), power supply and connecting cable with facing tape tightly.

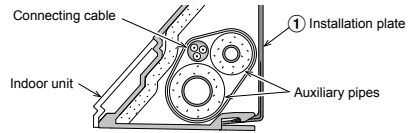

- Carefully arrange pipes so that any pipe does not stick out of the rear plate of the indoor unit.
- Carefully connect the auxiliary pipes and connecting pipes to one another and cut off the insulating tape wound on the connecting pipe to avoid double-taping at the joint; moreover, seal the joint with the vinyl tape, etc.
- Since dewing results in a machine trouble, make sure to insulate both connecting pipes. (Use polyethylene foam as insulating material.)
- When bending a pipe, carefully do it, not to crush it.

Indoor Unit Fixing

- Pass the pipe through the hole in the wall and hook the indoor unit on the installation plate at the upper hook.
- Swing the indoor unit to right and left to confirm that it is firmly hooked up on the installation plate.
- While pressing the indoor unit onto the wall, hook it at the lower part on the installation plate. Pull the indoor unit toward you to confirm that it is firmly hooked up on the installation plate.

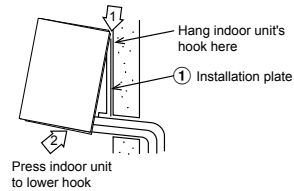

- For detaching the indoor unit from the installation plate, pull the indoor unit toward you while pushing its bottom up at the specified parts.

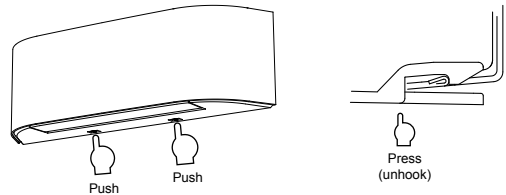

CAUTION

MOUNTING INDOOR UNIT TO THE INSTALLATION PLATE

- The lower part of indoor unit may float, due to the condition of piping and installer cannot fix it to the installation plate. In that case, use the screws provided to fix the indoor unit with the installation plate.
- Especially when the pipes are pulled out to the left side, the indoor unit must be screwed to the installation plate.

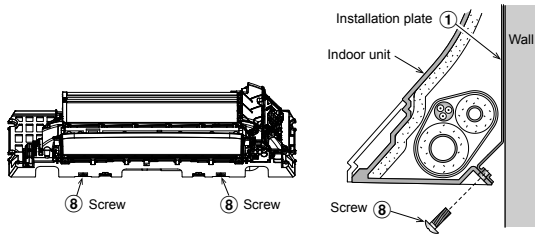

DIRECTLY MOUNTING INDOOR UNIT TO THE WALL

- In case left side or right of indoor unit may float, the provided screws should be used to fix the indoor unit directly to the wall at the predetermined position.
- In the case of block, brick, concrete or similar type wall, determining the mount screw position on the wall can be used symbol (▶) on the main body of indoor unit for drill hole to insert clip anchors for appropriate mounting screw.

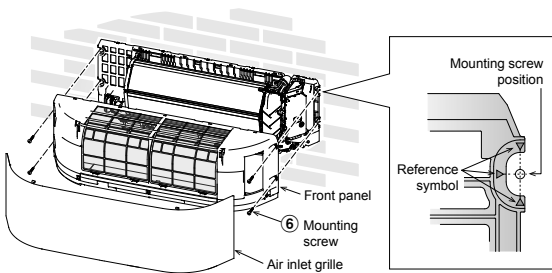

Drainage

- Run the drain hose sloped downwards.

NOTE

- The hole should be made at a slight downward slant on the outdoor side.

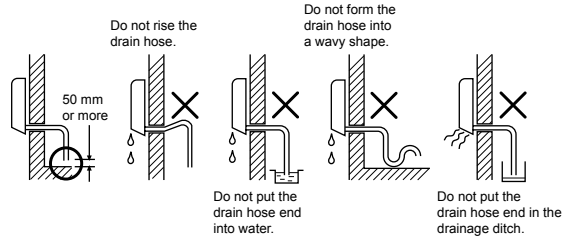

- Put water in the drain pan and make sure that the water is drained out of doors.
- When connecting extension drain hose, insulate the connecting part of extension drain hose with shield pipe.

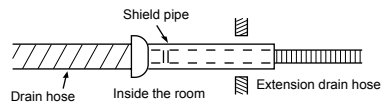

CAUTION

Arrange the drain pipe for proper drainage from the unit. Improper drainage can result in dew-dropping.

This air conditioner has the structure designed to drain water collected from dew, which forms on the back of the indoor unit, to the drain pan. Therefore, do not store the power cord and other parts at a height above the drain guide.

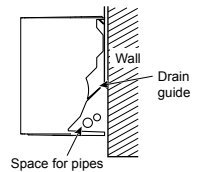

OUTDOOR UNIT

Installation Place

- A place which provides the spaces around the outdoor unit as shown in the diagram
- A place which can bear the weight of the outdoor unit and does not allow an increase in noise level and vibration
- A place where the operation noise and discharged air do not disturb your neighbors
- A place which is not exposed to a strong wind
- A place free of a leakage of combustible gases
- A place which does not block a passage
- When the outdoor unit is to be installed in an elevated position, be sure to secure its feet.
- The allowable length of the connecting pipe.

Model	38GCVPH010-303P	38GCVPH013-303P	38GCVPH018-303P
Chargeless	up to 15 m	up to 15 m	up to 15 m
Maximum length	20 m	20 m	20 m
Additional refrigerant charging	16 - 20 m (20 g / 1 m)	16 - 20 m (20 g / 1 m)	16 - 20 m (20 g / 1 m)
Maximum refrigerant charging	0.68 kg	0.90 kg	1.15 kg

- The allowable height of outdoor unit installation site.

Model	38GCVPH010-303P	38GCVPH013-303P	38GCVPH018-303P
Maximum height	12 m	12 m	12 m

- A place where the drain water does not raise any problems

Precautions for adding refrigerant

Use a scale having a precision with at least 10 g per index line when adding the refrigerant.

Do not use a bathroom scale or similar instrument.

CAUTION

When the outdoor unit is installed in a place where the drain water might cause any problems, Seal the water leakage point tightly using a silicone adhesive or caulking compound.

CAUTION

1. Install the outdoor unit without anything blocking the air discharging.
2. When the outdoor unit is installed in a place always exposed to strong wind like a coast or on a high storey of a building, secure the normal fan operation using a duct or a windshield.
3. In particularly windy areas, install the unit such as to avoid admission of wind.
4. Installation in the following places may result in trouble. Do not install the unit in such places.
 - A place full of machine oil
 - A saline-place such as the coast
 - A place full of sulfide gas
 - A place where high-frequency waves are likely to be generated as from audio equipment, welders, and medical equipment

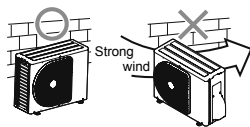

Refrigerant Piping Connection

Flaring

1. Cut the pipe with a pipe cutter.

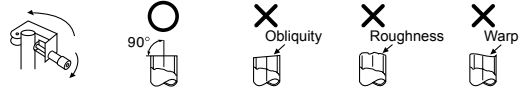

2. Insert a flare nut into the pipe and flare the pipe.

- Projection margin in flaring : A (Unit : mm)

RIDGID (clutch type)

Outer dia. of copper pipe	R32 tool used	Conventional tool used
Ø6.35	0 to 0.5	1.0 to 1.5
Ø9.52	0 to 0.5	1.0 to 1.5
Ø12.70	0 to 0.5	1.0 to 1.5
Pipes thickness	0.8 mm or more	

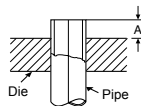

IMPERIAL (wing nut type)

Outer dia. of copper pipe	R32
Ø6.35	1.5 to 2.0
Ø9.52	1.5 to 2.0
Ø12.70	2.0 to 2.5
Pipes thickness	0.8 mm or more

CAUTION

- Do not scratch the inner surface of the flared part when removing burrs.
- Flare processing under the condition of scratches on the inner surface of flare processing part will cause refrigerant gas leak.

Tightening connection

Align the centers of the connecting pipes and tighten the flare nut as far as possible with your fingers. Then tighten the nut with a spanner and torque wrench as shown in the figure.

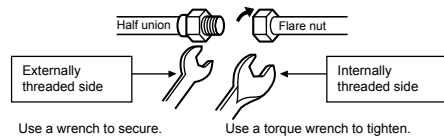

CAUTION

Do not apply excess torque. Otherwise, the nut may crack depending on the conditions.

(Unit : N·m)

Outer dia. of copper pipe	Tightening torque
Ø6.35 mm	16 to 18 (1.6 to 1.8 kgf·m)
Ø9.52 mm	30 to 42 (3.0 to 4.2 kgf·m)
Ø12.70 mm	50 to 62 (5.0 to 6.2 kgf·m)

Tightening torque of flare pipe connections

The operating pressure of R32 is higher than that of R22 (approx. 1.6 times). It is therefore necessary to firmly tighten the flare pipe connecting sections (which connect the indoor and outdoor units) up to the specified tightening torque. Incorrect connections may cause not only a gas leakage, but also damage to the refrigeration cycle.

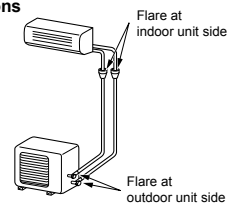

Evacuating

After the piping has been connected to the indoor unit, you can perform the air purge together at once.

AIR PURGE

Evacuate the air in the connecting pipes and in the indoor unit using a vacuum pump. Do not use the refrigerant in the outdoor unit. For details, see the manual of the vacuum pump.

Using a vacuum pump

Be sure to use a vacuum pump with counter-flow prevention function so that inside oil of the pump does not flow backward into pipes of the air conditioner when the pump stops.

(If oil inside of the vacuum pump enters the air conditioner, which use R32, refrigeration cycle trouble may result.)

1. Connect the charge hose from the manifold valve to the service port of the packed valve at gas side.
2. Connect the charge hose to the port of the vacuum pump.
3. Open fully the low pressure side handle of the gauge manifold valve.
4. Operate the vacuum pump to start evacuating. Perform evacuating for about 15 minutes if the piping length is 20 meters. (15 minutes for 20 meters) (assuming a pump capacity of 27 liters per minute)
Then confirm that the compound pressure gauge reading is -101 kPa (-76 cmHg).
5. Close the low pressure side valve handle of the gauge manifold valve.
6. Open fully the valve stem of the packed valves (both gas and liquid sides).
7. Remove the charging hose from the service port.
8. Securely tighten the caps on the packed valves.

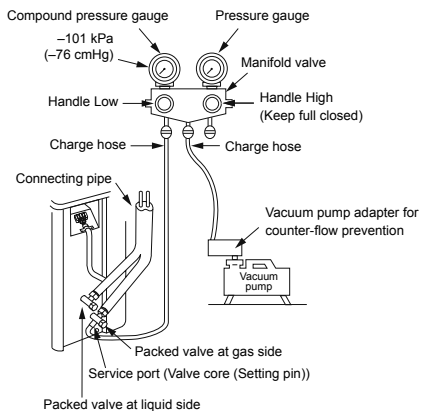

CAUTION

- **KEEP IMPORTANT 7 POINTS FOR PIPING WORK.**
 - (1) Take away dust and moisture (inside of the connecting pipes).
 - (2) Tighten the connections (between pipes and unit).
 - (3) Evacuate the air in the connecting pipes using a VACUUM PUMP.
 - (4) Check gas leak (connected points).
 - (5) Be sure to fully open the packed valves before operation.
 - (6) Reusable mechanical connectors and flared joints are not allowed indoors. When mechanical connectors are reused indoors, sealing parts shall be renewed. When flared joints are reused indoors, the flare part shall be refabricated.
 - (7) Don't operate air conditioner in case no refrigerant in the system.

Packed valve handling precautions

- Open the valve stem all the way out, but do not try to open it beyond the stopper.

Pipe size of Packed Valve	Size of Hexagon wrench
12.70 mm and smaller	A = 4 mm
15.88 mm	A = 5 mm

Pump down process

1. Turn off the Air Conditioner system.
2. Connect the charge hose from the manifold valve to the service port of the packed valve at gas side.
3. Turn on the Air Conditioner system in cooling operation more than 10 minutes.
4. Check the operating pressure of the system should be normal value. (Ref. with product specification)
5. Release the valve rod cap of both service valves.
6. Use the Hexagon wrench to turning the valve rod of Liquid side fully close. (*Make sure no entering air into the system)
7. Continue operate Air Conditioner system until the gauge of manifold dropped into the range of $0.5 - 0$ kgf/cm²
8. Use the Hexagon wrench to turning the valve rod of Gas side fully close. And turn off the Air Conditioner system immediately thereafter.
9. Remove the gauge manifold from the service port of the packed valve.
10. Securely tighten the valve rod cap to the both service valves.

CAUTION

Should be check the compressor operating condition while pumping down process. It must not any abnormal sound, more vibration. It is abnormal condition appears and must turn off the Air Conditioner immediately.

- Securely tighten the valve cap with torque in the following table:

Cap	Cap Size (H)	Torque
Valve Rod Cap	H17 - H19	14~18 N·m (1.4 to 1.8 kgf·m)
	H22 - H30	33~42 N·m (3.3 to 4.2 kgf·m)
Service Port Cap	H14	8~12 N·m (0.8 to 1.2 kgf·m)
	H17	14~18 N·m (1.4 to 1.8 kgf·m)

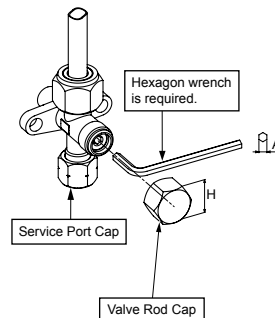

ELECTRICAL WORKS

Model	42GCVPH010-303P	42GCVPH013-303P	42GCVPH018-303P
Power source	60Hz, 220 - 230V Single phase		
Maximum running current	5.30A	6.30A	9.80A
Circuit breaker rating	15A	15A	15A
Power supply cable	H07RN-F or 60245 IEC66 (1.25 mm ² or more)		H07RN-F or 60245 IEC66 (1.5 mm ² or more)
Connecting cable	H07RN-F or 60245 IEC66 (0.75 mm ² or more)		

Indoor unit

Wiring of the connecting cable can be carried out without removing the front panel.

1. Remove the air inlet grille.
Open the air inlet grille upward and pull it toward you.
2. Remove the terminal cover and cord clamp.
3. Insert the connecting cable (according to the local cords) into the pipe hole on the wall.
4. Take out the connecting cable through the cable slot on the rear panel so that it protrudes about 20 cm from the front.
5. Insert the connecting cable fully into the terminal block and secure it tightly with screws.
6. Tightening torque : 1.2 N·m (0.12 kgf·m)
7. Secure the connecting cable with the cord clamp.
8. Fix the terminal cover, rear plate bushing and air inlet grille on the indoor unit.

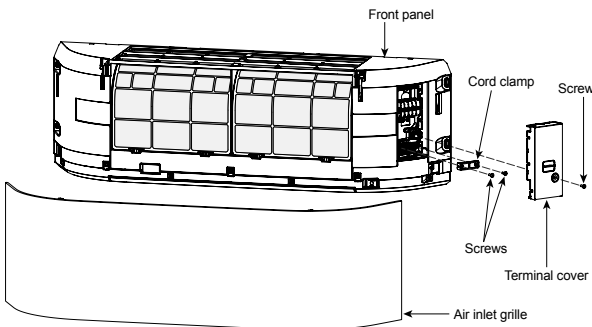

Outdoor unit

1. Remove the valve cover, the electric parts cover and the cord clamp from the outdoor unit.
2. Connect the connecting cable to the terminal as identified by the matching numbers on the terminal block of indoor and outdoor unit.
3. Insert the power cord and the connecting cable carefully into the terminal block and secure it tightly with screws.
4. Use vinyl tape, etc. to insulate the cords which are not going to be used. Locate them so that they do not touch any electrical or metal parts.
5. Secure the power cord and the connecting cable with the cord clamp.
6. Attach the electric parts cover and the valve cover on the outdoor unit.

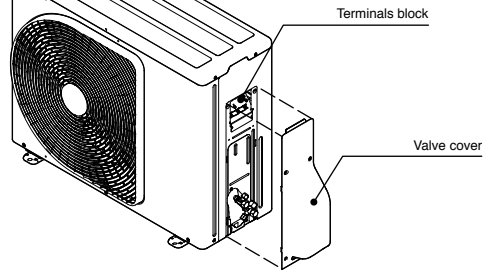

How to install the air inlet grille on the indoor unit

- When attaching the air inlet grille, the contrary of the removed operation is performed.

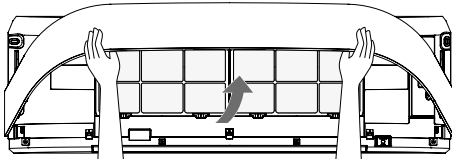

Power Supply and Connecting Cable Connection

Power Supply Input at Outdoor Unit Terminal Block

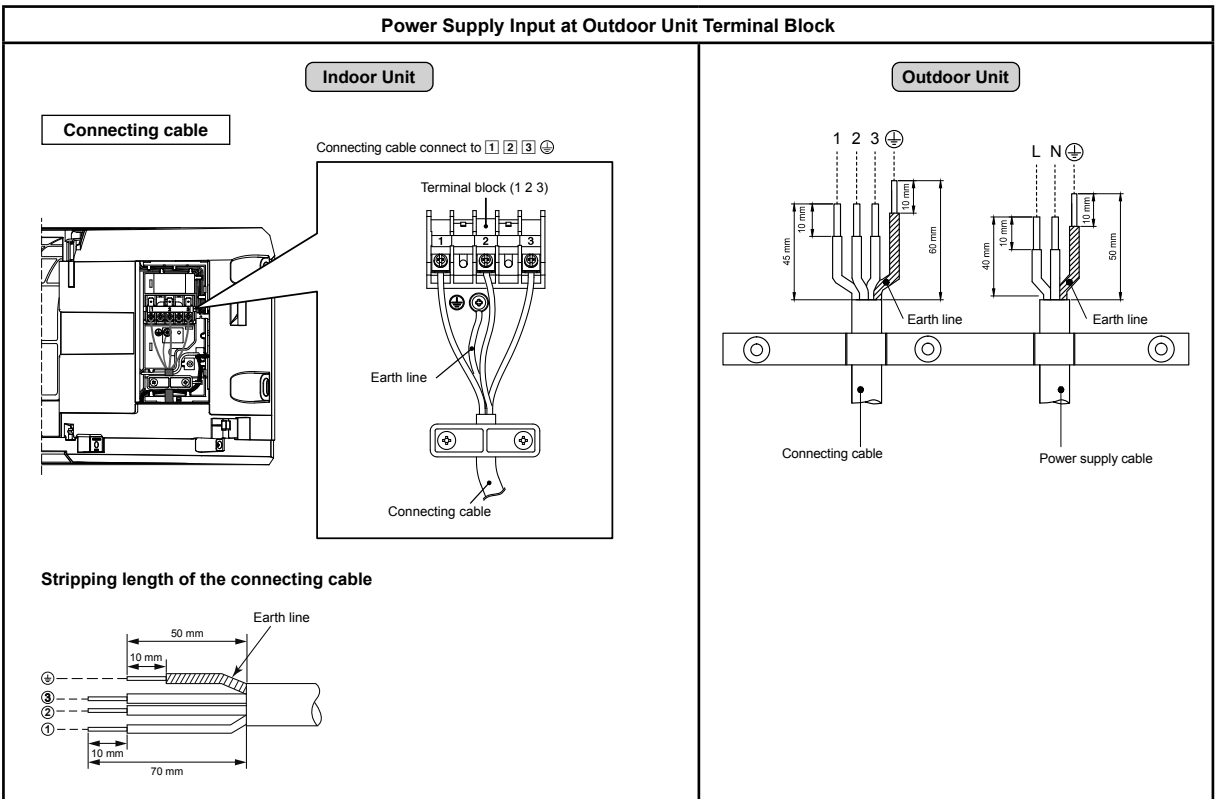

Power Supply Input Wiring Diagram

Power input at Outdoor Terminal Block

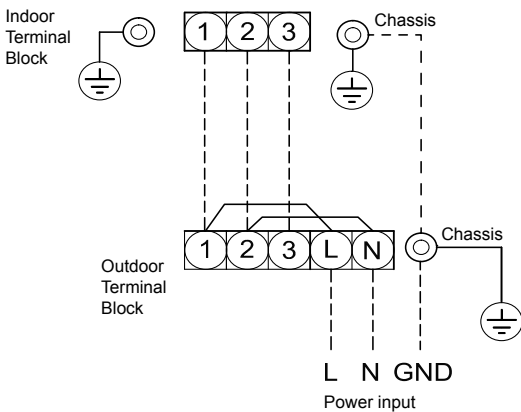

CAUTION

1. The power supply must be same as the rated of air conditioner.
 2. Prepare the power source for exclusive use with air conditioner.
 3. Circuit breaker must be used for the power supply line of this air conditioner.
 4. Be sure to comply power supply and connecting cable for size and wiring method.
 5. Every wire must be connected firmly.
 6. Perform wiring works so as to allow a general wiring capacity.
 7. Wrong wiring connection may cause some electrical part burn out.
 8. Incorrect or incomplete wiring is carried out, it will cause an ignition or smoke.
 9. This product can be connected to main power supply.
- Connection to fixed wiring : A switch which disconnects all poles and has a contact separation at least 3 mm must be incorporated in the fixed wiring.

OTHERS

Gas Leak Test

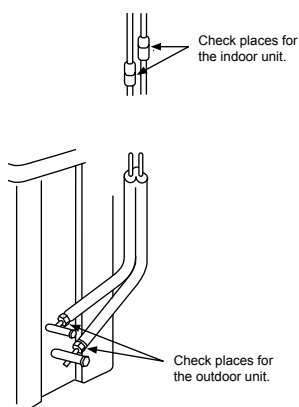

- Check the flare nut connections for the gas leak with a gas leak detector or soap water.

Remote Control A-B Selection

- When two indoor units are installed in the same room or adjacent two rooms, if operating a unit, two units may receive the remote control signal simultaneously and operate. In this case, the operation can be preserved by setting either one remote control to B setting. (Both are set to A setting in factory shipment.)
- The remote control signal is not received when the settings of indoor unit and remote control are different.
- There is no relation between A setting/B setting and A room/B room when connecting the piping and cables.

To separate using of remote control for each indoor unit in case of 2 air conditioner are installed near.

Remote Control B Setup.

1. Press [RESET] button on the indoor unit to turn the air conditioner ON.
2. Point the remote control at the indoor unit.
3. Push and hold [CHECK] button on back side of Remote Control. "00" will be shown on the display (Picture ①).

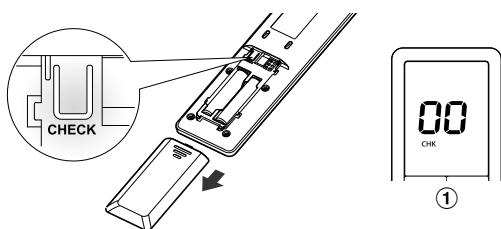

4. Press [MODE] during pushing [CHECK]. "B" will show on the display and "00" will disappear and the air conditioner will turn OFF. The Remote Control B is memorized (Picture ②).

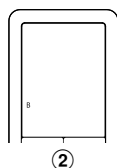

- Note :**
1. Repeat above step to reset Remote Control to be A.
 2. Remote Control A have not "A" display.
 3. Default setting of Remote Control from factory is A.

Test Operation

To switch the TEST RUN (COOL) mode, press [RESET] button for 10 seconds. (The beeper will make a short beep.)

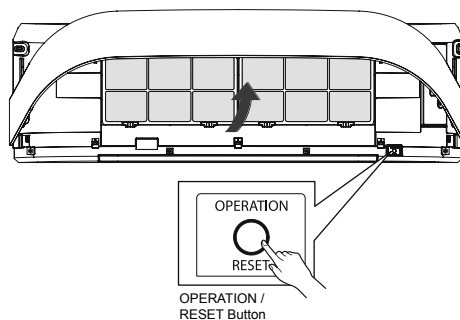

Auto Restart Function Setting

This product is designed so that, after a power failure, it can restart automatically in the same operating mode as before the power failure.

Information

The product is shipped with Auto Restart function in the ON position. Turn it OFF if this function is not required.

How to turn OFF the Auto Restart Function

- Press and hold the [OPERATION] button on the indoor unit for 3 seconds (3 beep sounds but OPERATION lamp does not blink).

How to turn ON the Auto Restart Function

- Press and hold the [OPERATION] button on the indoor unit for 3 seconds (3 beep sounds and OPERATION lamp blink 5 time/sec for 5 seconds).

NOTE

- In case of ON timer or OFF timer are set, AUTO RESTART OPERATION does not activate.

Decorative Fabric Installation

The decorative fabric for cover on the air inlet grille of indoor unit was put in the accessories. User can use it as required.
The method of installation is as follows.

1. Remove the air inlet grille.
Open the air inlet grille upward and pull it toward you.
As shown on figure as below.

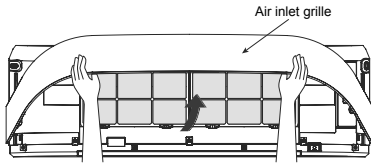

2. Prepare the fabric that you choose for install.
3. Insert the fabric into the left and right side of the air inlet grille and adjust corner position of decorative fabric is smooth.
Attach the hook and loop of velcro tape fully together.
As shown on figure as below.

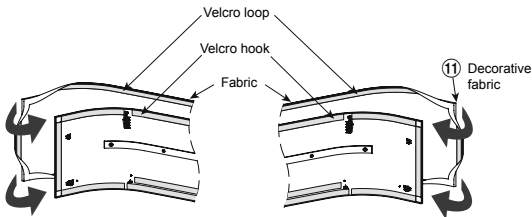

4. Insert the fabric into the top and bottom side of the air inlet grille.
Attach the hook and loop of velcro tape fully together.
As shown on figure as below.

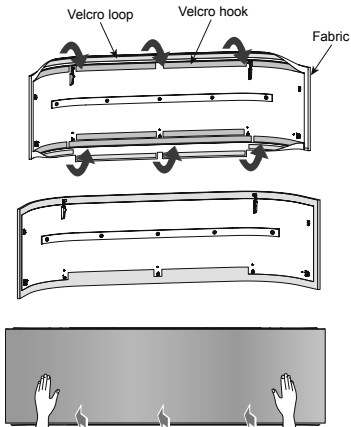

5. Reassembly the air inlet grille by reverse process of 1.

NOTE

- The tightness of the fabric depends on attaching the hook and loop of velcro around the air inlet grille, take appropriate action.

CAUTION

- If clean decorative fabric by washing, it may affect to appearance and fitting of the decorative fabric.
- Recommend to use vacuum cleaner to removing the dusts from decorative fabric.

APPENDIX

Work instructions

The existing R22 and R410A piping can be reused for inverter R32 product installations.



WARNING

Confirming the existence of scratches or dents on the existing pipes and confirming the reliability of the pipe strength are conventionally referred to the local site. If the specified conditions can be cleared, it is possible to update existing R22 and R410A pipes to those for R32 models.

Basic conditions needed to reuse existing pipes

Check and observe the presence of three conditions in the refrigerant piping works.

- Dry** (There is no moisture inside of the pipes.)
- Clean** (There is no dust inside of the pipes.)
- Tight** (There are no refrigerant leaks.)

Restrictions for use of existing pipes

In the following cases, the existing pipes should not be reused as they are. Clean the existing pipes or exchange them with new pipes.

- When a scratch or dent is heavy, be sure to use new pipes for the refrigerant piping works.
- When the existing pipe thickness is thinner than the specified "Pipe diameter and thickness," be sure to use new pipes for the refrigerant piping works.
 - The operating pressure of R32 is high (1.6 times that of R22). If there is a scratch or dent on the pipe or a thinner pipe is used, the pressure strength may be inadequate, which may cause the pipe to break in the worst case.

* Pipe diameter and thickness (mm)

Pipe outer diameter	Ø6.4	Ø9.5	Ø12.7
Thickness	R32, R410A R22	0.8	0.8

- When the outdoor unit was left with the pipes disconnected, or the gas leaked from the pipes and the pipes were not repaired and refilled.
 - There is the possibility of rain water or air, including moisture, entering the pipe.
- When refrigerant cannot be recovered using a refrigerant recovery unit.
 - There is the possibility that a large quantity of dry oil or moisture remains inside the pipes.

- When a commercially available dryer is attached to the existing pipes.
 - There is the possibility that copper green rust has been generated.

- When the existing air conditioner is removed after refrigerant has been recovered.
 - Check if the oil is judged to be clearly different from normal oil.

- The refrigerant oil is copper rust green in color. There is the possibility that moisture has mixed with the oil and rust has been generated inside the pipe.
 - There is discolored oil, a large quantity of residue, or a bad smell.
 - A large quantity of shiny metal dust or other wear residue can be seen in the refrigerant oil.
- When the air conditioner has a history of the compressor failing and being replaced.
 - When discolored oil, a large quantity of residue, shiny metal dust, or other wear residue or mixture of foreign matter is observed, trouble will occur.
 - When temporary installation and removal of the air conditioner are repeated such as when leased etc.
 - If the type of refrigerant oil of the existing air conditioner is other than the following oil (Mineral oil, Suniso, Freol-S, MS (Synthetic oil), alkyl benzene (HAB, Barrel-freeze), ester series, PVE only of ether series.
 - The winding-insulation of the compressor may deteriorate.

NOTE

The above descriptions are results have been confirmed by our company and represent our views on our air conditioners, but do not guarantee the use of the existing pipes of air conditioners that have adopted R32 in other companies.

Curing of pipes

When removing and opening the indoor or outdoor unit for a long time, cure the pipes as follows:

- Otherwise rust may be generated when moisture or foreign matter due to condensation enters the pipes.
- The rust cannot be removed by cleaning, and new pipes are necessary.

Placement location	Term	Curing manner
Outdoors	1 month or more	Pinching
Indoors	Less than 1 month Every time	Pinching or taping

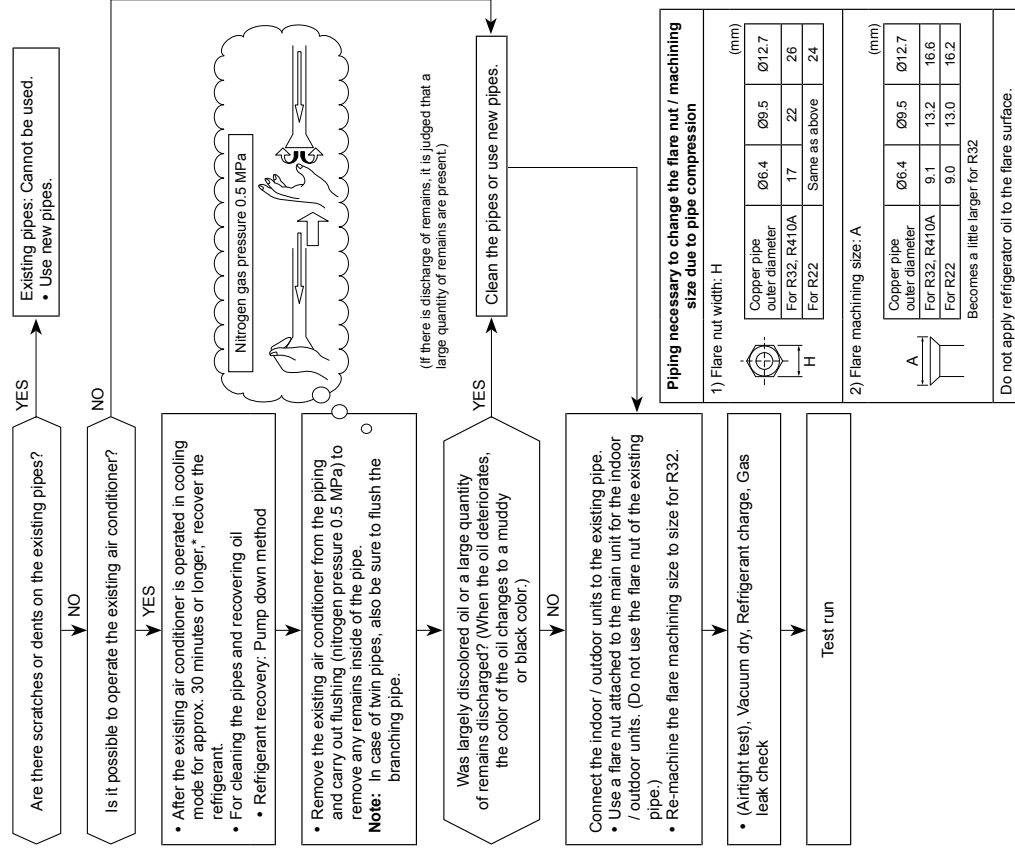

Piping necessary to change the flare nut / machining size due to pipe compression

1) Flare nut width: H

Copper pipe outer diameter	Ø6.4	Ø9.5	Ø12.7
For R32, R410A	17	22	26
For R22	Same as above		

2) Flare machining size: A

Copper pipe outer diameter	Ø6.4	Ø9.5	Ø12.7
For R32, R410A	9.1	13.2	16.6
For R22	9.0		

Becomes a little larger for R32

Do not apply refrigerator oil to the flare surface.



Carrier



1129850113